

User Manual

New friendly GUI design
SOC Support
Screen Zoom
Remote Control



VIEW **3** Pro

**MONITORING WEB SERVICE
CLAD-ALIGNMENT FUSION SPICER**

Please read this manual before operating your fusion splicer, and keep it for future reference.

Content

Preface	4
Chapter 1 Technical Parameters	5
1.1 Applicable Fiber Type.....	5
1.2 Splice Loss.....	5
1.3 Splice Mode.....	5
1.4 Heat Oven.....	5
1.5 Power Supply.....	5
1.6 Size and Weight.....	5
1.7 Environmental Conditions.....	5
1.8 Others.....	5
1.9 Battery precautions.....	6
Chapter 2 Installation	7
2.1 Safety Warning and Precautions.....	7
2.2 Installation.....	8
2.3 Overview of External Parts.....	9
2.4 Power Supply Method.....	10
Chapter 3 Basic Operation	11
3.1 Turn On the Splicer.....	11
3.2 Preparing the Fiber.....	12
3.3 How to Make a Splice.....	12
3.4 How to Protect the Splice.....	13
Chapter 4 Splice Mode	15
4.1 Displaying the Active Splice.....	15
4.2 Selecting a Splice Mode.....	15
4.3 General Splicing Steps.....	16
4.4 Parameters for Normal Splicing Process.....	17
Chapter 5 Splice Option	18
5.1 Splice Mode Setting.....	18
Chapter 6 Heater Mode	19
6.1 Selecting Heater Mode.....	19
6.2 Editing Heat Mode.....	19
6.3 Delete Heat Mode.....	20
Chapter 7 Maintenance Menu	21
7.1 Maintenance.....	21

7.2 Replace Electrodes.....	21
7.3 Stabilize Electrodes.....	22
7.4 Motor Calibration.....	22
7.5 Dust Check.....	23
7.6 Electrode Setting.....	23
7.7 Update Software.....	23
Chapter 8 Other Functions & Utilities	24
8.1 Data Storage.....	24
8.2 Menu Lock.....	24
8.2 System Setting.....	24
8.3 Time Lock.....	25
8.3.1 Time Lock setting.....	25
8.3.2 Remark.....	25
8.4 System Setting.....	25
8.5 System Information.....	26
Chapter 9 VIEW PRO MANAGER	27
9.1 Preparation.....	27
9.2 Network Setting.....	27
9.3 Access to VIEW PRO MANAGER Website.....	28
9.4 Create New Account.....	28
9.5 Register the Device.....	29
9.6 Feature of VIEW PRO MANAGER.....	30
9.6.1 Monitor.....	30
9.6.2 Record.....	30
Appendix I.....	32
Appendix II.....	33
Appendix III.....	35

Preface

Thank you for choosing VIEW 3 Pro Arc Fusion Splicer from INNO Instrument. VIEW 3 Pro adopts innovative product design and exquisite manufacturing technology so as to deliver unprecedented splicing experience to customers.

The totally new technology greatly reduces splicing and heating time, and advanced estimation method and alignment technique ensure the accuracy of splice loss estimation. The simple-but-trendy product design, sophisticated internal structure and reliable durability make the splicer be suitable for any operating environment. Dynamic operation interface and automatic splice mode provide users great convenience.

For more information of VIEW 3 Pro , please visit our official website at www.innoinstrument.com.



Equipped with FH-45 fiber holder
(Standard package)
Model: FH-45
(Extra Detachable Holders are contained in the Kit)



This User Manual explains the use, performance characteristics, and cautions about VIEW 3 Pro fusion splicer and how to install and operate it. The primary goal of this manual is to make the user as familiar with the splicer as possible.

Important!

INNO Instrument recommends all users to read this manual before operating VIEW 3 Pro fusion splicer.

Chapter1 - Technical Parameters

1.1 Applicable Fiber Type

- * SM(ITU-T G.652&T G.657)/MM(ITU-T G.651)/DS(ITU-T G.653)/NZDS (ITU-T G.655)
- * Fiber count: Single
- * Applicable fiber / cable diameter: 0.2mm to 3.0mm/Indoor Cable
- * Applicable fiber diameter: Cladding diameter: 100 to 125 μ m

1.2 Splice Loss

Same fiber is spliced, measured by cut-back method relevant to ITU-T standard. The typical values of splice loss are:

- * SM:0.03dB
- * MM:0.01dB
- * DS:0.05dB
- * NZDS:0.05dB
- * G.657:0.03dB

1.3 Splice Mode

- * It can be preset 128 kinds of splice mode.
- * It can store 10000 records of the latest splice results.
- * Splice time: Quick Mode : 7 sec (Avg.) / SM Auto Mode : 9 sec (Avg.)

1.4 Heat Oven

- * 5 kinds of applicable protection sleeve: 20mm, 30mm, 40mm, 50mm, 60mm.
- * Heating time: 8 to 900s optional.
- * Typical heating time: 13 sec (45mm, slim 60mm), 15 sec(60mm)
- * Heating mode: Various in-built heat modes available.
- * Heater: Specific heater for VIEW 3 Pro fusion splicer.

1.5 Power Supply

- * Standard AC power voltage: AC 100 to 240V, 50 to 60Hz;
- * Standard DC power voltage: DC 9 to 14V

1.6 Size and Weight

- * Size: Length \times width \times height= 149W x 177D x 151H mm (including rubber bumper)
130W x 166D x 140H mm (excluding rubber bumper)
- * weight: 2.21kg (with battery) / 1.85kg (without battery)

1.7 Environmental Conditions

- * Operating conditions: altitude: 0 to 5000m, relative humidity: 0 to 95%, temperature: -10 to 50 °C , the maximum wind velocity: 15m / s;
- * Storage conditions: relative humidity: 0 to 95%, temperature: -20 to 60 °C , battery: -20 to 30 °C for long-term storage.

1.8 Other

- * Observation and display: Two cameras, 5-inch color LCD display, Full touch screen.
- * 320x magnification for single X or Y view, or 520x magnification for double click X or Y view.
- * Pull test: 1.96 to 2.25N.
- * Terminals: Type C / SIM.

1.9 Battery precautions

- 1) Do not touch or hit battery with pointed or sharp items.
- 2) Do not transport or store the battery together with metals.
- 3) Do not throw, drop, impact, or bend battery, or any knock or stomp on the battery is forbidden.
- 4) Do not connect the anode and cathode terminals of the battery with metals such as electric wire for fear of short circuit trouble.
- 5) Do not allow battery's anode or cathode terminal to touch with the aluminum layer of package made from aluminum laminated plastic film material for fear of short-circuit.
- 6) In no case the battery cell can be dismantled.
- 7) Do not immerse the battery into water or seawater, because the battery cell cannot bear moist environment.
- 8) Do not place or use the battery beside or near the heat source such as fire or heater.
- 9) Do not heat battery or throw it into water.
- 10) Do not directly solder the battery.
- 11) Do not charge battery near or beside the fire or in a very hot environment.
- 12) Do not place the battery into microwave oven or any high pressure vessel.
- 13) Do not allow the battery work or place it in hot temperatures such as in strong sunshine or hot environment in car for a long time, for fear that battery might be overheated, on fire, weakened functionally, or shortened in life.
- 14) Any usage of the damaged battery is forbidden. The battery should be kept away from fire source when electrolyte leakage occurs or the battery emits electrolyte smell for fear battery might catch on fire or explode.

Chapter 2 - Installation

2.1 Safety Warning and Precautions

As VIEW 3 Pro is designed for fusion splicing silica glass optical fibers, it is very important that the splicer should not be used for any other purposes. The splicer is a precision instrument and must be handled with caution. Therefore, you must read the following safety rules and general precautions in this manual regarding the use and handling of VIEW 3 Pro at any time. Any behaviors that do not follow the warnings and cautions will break the safety standard about design, manufacture, and usage of the fusion splicer. INNO Instrument will not take the responsibility for those consequences caused by misuse!

Operational Safety Warnings

- ① Never operate the splicer in an environment where flammable liquids or vapors exist.
- ② DO NOT touch the electrodes when the splicer is on.

⚠ Note:

Only use specified electrodes for the fusion splicer. Select [Replace electrode] in maintenance menu to replace electrodes, or turn off the splicer and disconnect the AC power source or remove battery before replacing electrodes. Discharging is prohibited before the electrodes are placed as a pair.

- ③ DO NOT disassemble or modify any components of the splicer without approval, except for the permitted-to-disassemble / modify components or parts by users stated in this manual. Component replacement and its internal adjustment must be implemented by INNO or its authorized technicians or engineers.
- ④ Never operate the splicer in an environment where flammable liquids or vapors exist. Risk of dangerous fire or explosion could result from the splicer's electrical arc in such an environment. DO NOT operate the splicer near heat source or in high temperature and dusty /environment, or when condensation is present on the splicer. This may result in electric shock, splicer malfunction, or poor splicing performance.
- ⑤ Safety glasses should always be worn during fiber preparation and splicing operation. Fiber fragments can be extremely dangerous if they come into contact with the eye, skin, or are ingested.
- ⑥ Take out the battery immediately if the followings are observed when using the splicer:
 - * Fumes, bad smell, abnormal noise or over heat.
 - * Liquid or other matter falls into cabinet
 - * The splicer is damaged or dropped.If any of these faults occurs, please contact our service center immediately. Leaving the splicer in a damaged state without any prompt measures may cause equipment failure, electric shock, or fire and may result in injury or death.
- ⑦ Do not use compressed gas or canned air to clean the splicer. They may contain flammable materials that could ignite during the electrical discharge.
- ⑧ Please use VIEW 3 Pro specific standard battery only. Using an improper AC power source may cause fuming, electric shock or equipment damage and may even result in fire, injury or death.
- ⑨ Please use VIEW 3 Pro specific charger only. Do not place any heavy objects on the AC power cord. Keep the power cord away from heat source. Using an improper cord or a damaged cord may cause fuming, electric shock or equipment damage and may even result in fire, injury or death.

Maintenance and External Care Precautions

- ① Always avoid using hard objects to clean V-grooves and electrodes.
- ② Always avoid using acetone, thinner, benzol or alcohol when cleaning any part of the splicer, except for the places advised.
- ③ Use a dry cloth to remove dust and dirt from the splicer.
- ④ If the outside of the splicer is dirty, plunge a soft cloth into diluted neutral washing up liquid, wring out the cloth and clean. Dry the splicer with a dry cloth but DO NOT use furniture polish or other cleaning agents.
- ⑤ Always follow the maintenance instructions in this manual.

Transport and Storage Precautions

- ① When the splicer is moved from cold to warm environment, you should allow the splicer to warm up gradually. Otherwise, the condensation generated inside will bring harmful effects to the splicer.
- ② Pack the fusion splicer well for long time storage.
- ③ Keep the splicer clean and dry.
- ④ The splicer is precision adjusted and aligned. Always keep the splicer in its carrying case to protect from damage and dirt. Put cushion package outside the carrying case for long distance transportation.
- ⑤ Always avoid leaving the splicer in direct sunlight or expose to excessive heat.
- ⑥ DO NOT store the splicer in dusty or environment. This may result in electric shock, splicer malfunction or poor splicing performance.
- ⑦ Keep the humidity to a minimum level where the splicer is stored. The humidity must not exceed 95%.

2.2 Installation

⚠ Important!

Follow these instructions carefully.

Unpacking the Splicer

Hold the handle upwards, and then lift the splicer out of the carrying case. As shown below.



2.3 Overview of External Parts

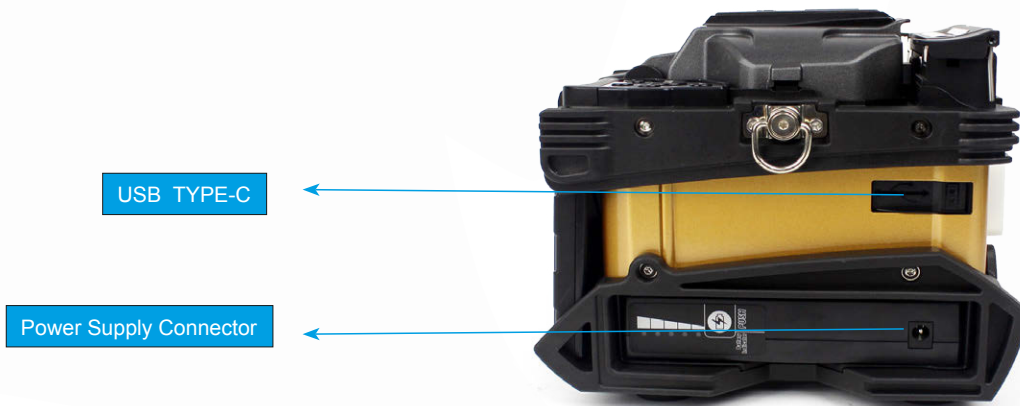

2.4 Power Supply Method

Battery

Following is the way of installing a battery.



Chapter 3 - Basic Operation

3.1 Turn On the Splicer

Press  button on the operation panel, and wait the splicer to be turned on and move to Workbench page.

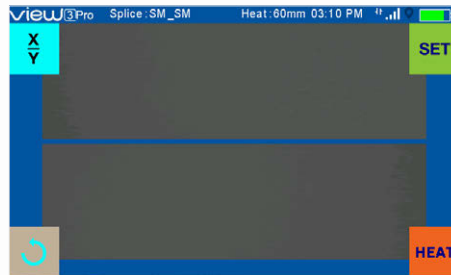

Note:

The LCD monitor is a precise component produced by manufacturing factory under strict quality control. However, some tiny dots in different colors may still remain on the screen. Meanwhile, the screen brightness may not appear uniform, depending on its viewing angles. Note that these symptoms are not defects, but are natural phenomenon.

3.2 Preparing the Fiber

3 steps should be carried out before splicing:

1. Stripping

Remove at least 50mm of secondary coating (valid for both tight and loose tube secondary coating) and approximately 30~40mm of primary coating with an appropriate stripper.

2. Clean bare fibers with pure alcohol-soaked gauze or lint-free tissue.

3. Cleave the fiber

In order to ensure the best splicing result, cleave the fibers with high precision cleaver such as INNO Instrument V series fiber cleaver, and strictly control the cleaving lengths shown as below.

Note:

Always remember to slip a heat-shrinkable sleeve onto either end of the fibers at the beginning of each fiber preparations.

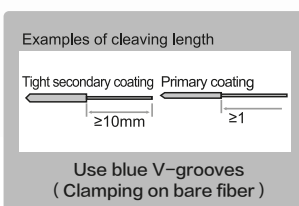

Important!

Make sure that the bare fiber and its cleaved section are clean.

- Avoid putting the fibers down on a dusty working surface.
- Avoid waving the fibers around in the air.
- Check if the V-grooves are clean; if not, wipe them clean with pure alcohol-soaked cotton swab.
- Check whether the clamps are clean; if not, wipe them clean with pure alcohol-soaked cotton swab.

3.3 How to Make a Splice

Put the optical fiber in

- ① Open the safety shield.
- ② Raise the fiber clamps.
- ③ Position the fibers into V-grooves. Make sure the fiber ends are between the V-groove edges and the electrode tip.
- ④ Clamp the fiber in position by lowering both sets of fiber clamps.
- ⑤ Close the safety shield.

⚠ Note:

Make sure to avoid sliding the fibers along V-grooves, but rather position them over V-grooves and tilt them down into place (as shown below).

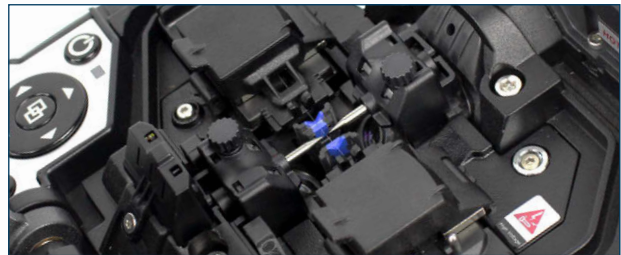
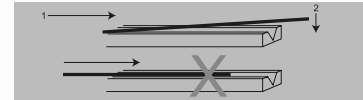

Inspecting the Fibers

Before continuing with splicing, inspect the fibers whether they are clean and well-cleaved. If any defects are found, please remove the fibers and prepare again.

a.

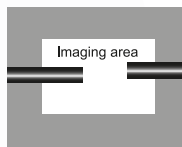

Fiber ends visible on the monitor.

b.

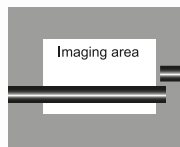

Fiber ends outside monitor.

c.

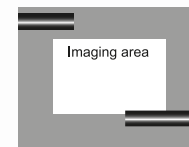

Fiber ends above and below monitor, not possible to find automatically.

⚠ Note:

The fibers are checked automatically when you press Set button. The splicer automatically focuses the fibers and checks for damage or dust particles.

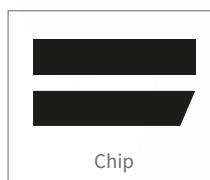
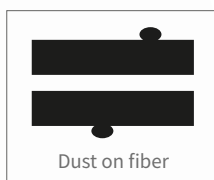

Splicing

- ① Select any appropriate splice mode.
- ② Start splicing by pressing “SET” button.

⚠ Note:

If the splicer is set as “Auto mode”, splicing will start automatically once the safety shield is closed.

3.4 How to Protect the Splice

After splicing, put the fiber with heat-shrink sleeve into the heat oven. Press [Heat] button to execute heat-shrink process to strengthen the splice point.

Heating Procedure

- ① Open the heat oven lid
- ② Lift the left and right fiber holders on the splicer. Hold the heat-shrink sleeve (previously placed onto the fiber). Lift the spliced fibers and hold them taut. Then move the heat-shrink sleeve to the splice point.
- ③ Place the fiber with heat-shrink sleeve in the heat oven clamp.
- ④ Press [Heat] button to start heating. Upon completion, the heating LED indicator will go off with buzzing.

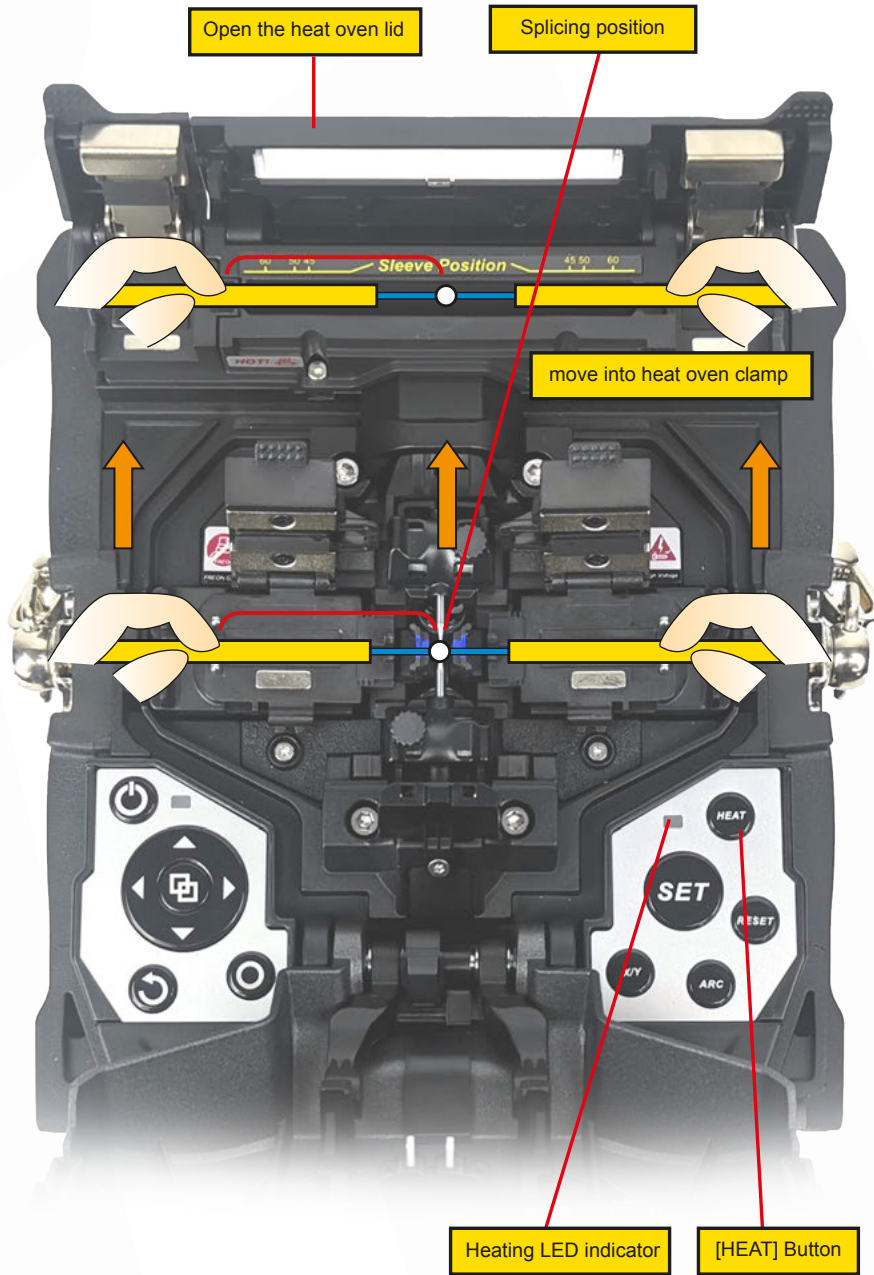

Chapter 4 - Splice Mode

VIEW 3 Pro has an intuitive and simple but very powerful program structure to operate. Splice programs define arc currents, splice times as well as various parameters used when performing a splice. Therefore, it is essential to select the correct splice program. There are a number of “Preset” splice programs for common fiber combinations. Therefore, it is much easier to modify and further optimize the parameters for more unusual fiber combinations.

4.1 Displaying the Active Splice

The active splice program is always displayed at the top of the screen (see below).

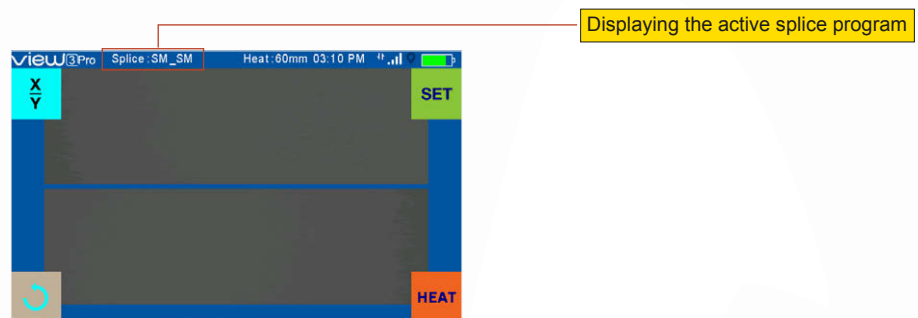

4.2 Selecting a Splice Mode

① Select [Splice mode] from the main menu.

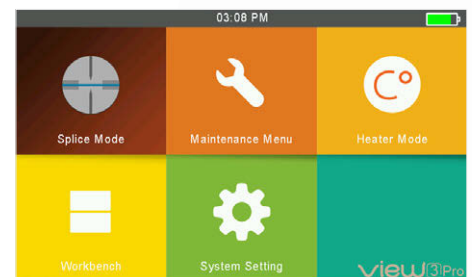

② Select an appropriate splice mode



③ Selected splice mode appears on the screen. Press [Reset] button to return to initial interface page.

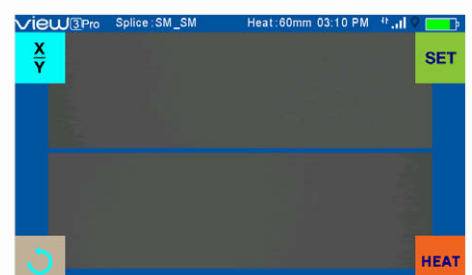

4.3 General Splicing Steps

This section explains the steps involved in automatic splicing process and describes how various program parameters are related to this process. The normal splicing process can be divided into two sections: pre-fusion and fusion.

Pre-Fusion

During pre-fusion, the splicer performs automatic alignment and focusing, where the fibers are subjected to a low pre-fusion current for cleaning purposes; a pre-fusion image is also taken. At this point, the user is informed of any problems recognized in the pre-fusion image, such as a poorly prepared fiber. The splicer will then issue a warning before the fibers are fused together.

Fusion

During fusion, the fibers are joined together and subjected to five different currents as illustrated below. An important parameter, which changes during splicing, is the distance between the fibers. During Pre-fusion, the fibers are apart. With the current phase changing, fibers are spliced gradually.

Splicing Process

Arc power and arc time are considered as the two most important parameters (as shown in the figure below). The name and purpose of those parameters as well as the effect and importance of the parameters will be described in the next section "Splice program parameters under general splicing process". The below figure shows the arc discharge conditions (relationship between "Arc power" and "Motor motion"). These conditions can be modified by changing the splicing parameters listed below. However, depending on the splice mode, certain parameters cannot be changed.

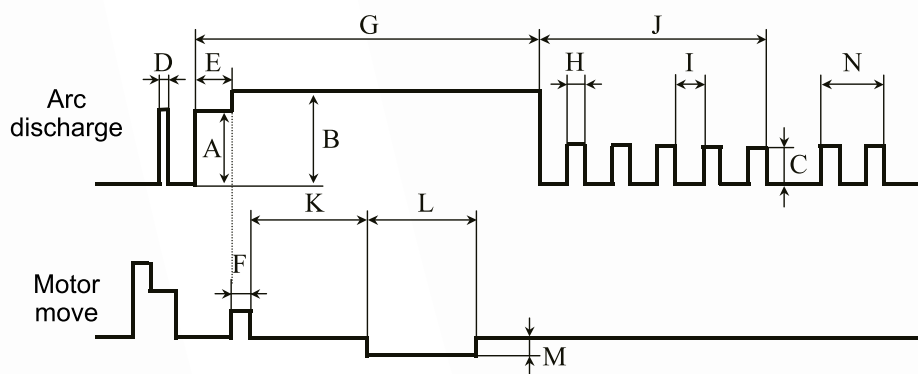

- A: Pre-fuse power B: Arc1 power C: Arc2 Power D: Cleaning Arc E: Pre-fuse Time
 F: Forward Time related to Overlap G: Arc1 time
 H: Arc2 ON time I: Arc2 OFF time J: Arc2 time
 K: Taper Splicing Wait Time L: Taper Splicing Time
 M: Taper Splicing speed N:Rearc Time

Diagram of ARC discharge condition

4.4 Parameters for Normal Splicing Process

Parameter	Description
Template	A list of splice modes stored in the splicer database is displayed. Upon inputting the appropriate mode, the selected splice mode stored in database area is copied to a selected splice mode in user-programmable area.
Name	Title for a splice mode expressed in up to seven characters.
Note	Detailed explanation for a splice mode expressed in up to 15 characters. It is displayed at "Select splice mode" menu.
Align Type	Set the aligning type for the fibers. "Core" : fiber core alignment
Arc adjust	Sets to adjust arc power according to the fibers' conditions.
Pull test	If "Pull test" is set to "ON", a pull-test is performed upon opening the windproof cover or by pressing the SET button after splicing.
Loss estimate	Loss estimate should be regarded as a reference. Since the loss is calculated upon the fiber image, there is certain difference with the real value. The estimate method is based on a single mode fiber and calculates at the wavelength of 1.31 μ m. The estimated value can be a valuable reference, but cannot be used as the basis of acceptance.
Minimum loss	This amount is added to the estimate splice loss originally calculated. When splicing specially or dissimilar fibers, a high actual splice loss may occur even with optimized arc conditions. To make the actual splice loss concur with the estimated splice loss, set the actual splice loss to minimum value (minimum loss).
Loss Limit	An error message is displayed if the estimated splice loss exceeds the selected threshold (loss limit).
Core angle limit	An error message is displayed if the bend angle of the two fibers spliced exceeds the selected threshold (Core angle limit).
Cleave angle limit	An error message is displayed if the cleave angle of either the left or right fiber ends exceed the selected threshold (cleave limit).
Gap position	Set the relative position of the splicing location to the center of electrodes. Splice loss may be improved in the case of dissimilar fiber splicing by shifting [Gap position] towards a fiber whose MFD is bigger than the other fiber MFD.
Gap	Set the end-face gap between the left and right fibers at the time of aligning and pre-fusion discharge.
Overlap	Set the overlape amount of fibers at the fiber propelling stage. Relatively small [Overlap] is recommended if [Preheat Arc Value] is low, while relatively large [Overlap] is recommended if [Preheat Arc Value] is high.
Cleaning Arc time	A cleaning arc burns out micro dust on the surface of the fiber with an arc discharge for a short period of time. The duration of the cleaning arc can be changed by this parameter.
Preheat Arc value	Set the pre-fuse arc power from the beginning of arc discharging to the beginning of fibers propelling. If "Preheat Arc Value" is set too low, axial offset may occur if cleaved angles are relatively poor. If "Preheat Arc Value" is set too high, fiber end faces are fused excessively and splice loss gets worse.
Preheat Arc time	Set the pre-fuse arc time from the beginning of arc discharging to the beginning of fibers propelling. Long [Preheat Arc Time] and high [Preheat Arc Value] lead to the same results.
Fuse Arc value	Set Arc power.
Fuse Arc time	Set Arc time.

Chapter 5 - Splice Option

5.1 Splice Mode Setting

- 1 Select [Splice option] in menu.
- 2 Select a parameter to be changed.

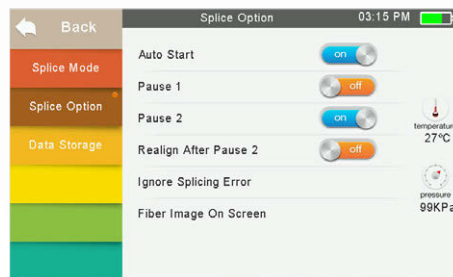

Parameter	Description
Auto start	If "Auto start" is set to ON, splicing starts automatically as soon as the wind protector is closed. Fibers should be prepared and placed into the splicer in advance.
Pause 1	If "Pause 1" is set to ON, splicing operation pauses when fibers are forwarded to gap-set position. Cleave angles are displayed during the pause.
Pause 2	If "Pause 2" is set to ON, splicing operation pauses after fiber alignment is completed.
Ignore splice error	
Cleave angle	Setting to "OFF" ignores the faults and continues to complete the splicing even if the message "Cleave Angle Error" appears.
Core angle	Setting to "OFF" ignores the faults and continues to complete the splicing even if the message "Core Angle Error" appears.
Loss	Setting to "OFF" ignores the faults and continues to complete the splicing even if the message "Loss Error", "Cleave Shape Error", "Fat Error", or "Thin Error" appears.
Fat	
Thin	
Fiber image on screen	
Pause 1	Set the displaying method of the fiber image on the screen during splicing operation.
Align	
Pause 2	
Arc	
Estimate	
Gap set	

Chapter 6 - Heater Mode

The splicer provides max 32 heat modes including 7 heat modes preset by INNO Instrument and the reset that can be defined by users.

Select a heating mode that best matches with the protection sleeve used.

For each type of protection sleeve, VIEW 3 Pro has its optimum heating mode. These modes can be found in the database area for reference. Copy the appropriate mode and paste it to the user-programmable area. Users can edit those parameters.

6.1 Selecting Heater Mode

Select [Select Heat Mode] in [Heater Mode] menu.

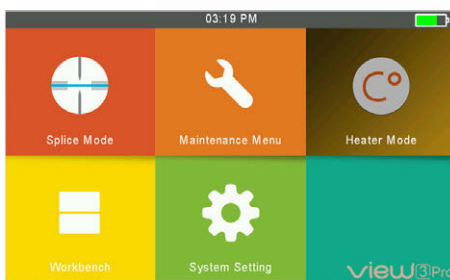

① Select [Heater Mode] menu.

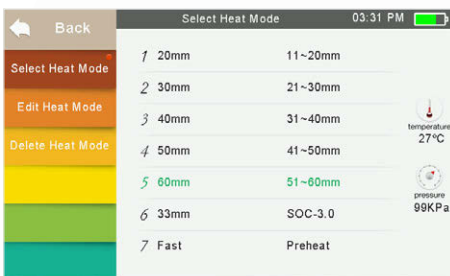

② Select heat mode.



③ Selected heat mode appears on the screen. Press [R] button to return to initial interface.

6.2 Editing Heat Mode

Heating conditions stored in heating mode can be edited or changed.

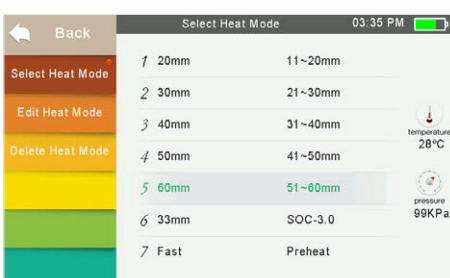

① Select [Edit Heat Mode] in [Heater mode] menu.

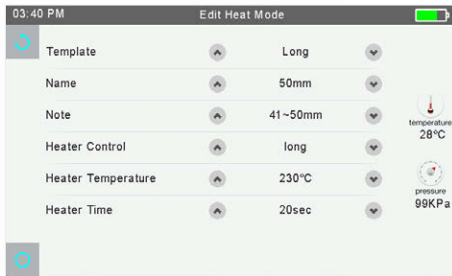

② Select the parameters to be edited.

6.3 Delete Heat Mode

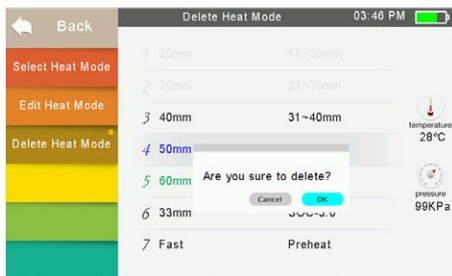

① Select [Heater Mode] menu.

② Select [Delete Heat Mode].

③ Select the heat mode to be deleted

⚠ Note:

The gray modes (20mm, 30mm) are the system preset initial heat modes which cannot be deleted

Heat Mode Parameters

Parameter	Description
Template	Set sleeve type. List of all heat modes are displayed. Selected mode will be copied to a user-programmable area.
Name	Title for a heat mode.
Note	Title of the heat mode displayed in the upper right corner of the monitor during splicing or heating process. Max number of characters used is 5.
Heater temperature	Sets heating temperature.
Heater time	Sets heating time from the beginning to the heating completed.
Preheat temperature	Sets preheat temperature of the heater.

Chapter 7 - Maintenance Menu

The splicer has a function to perform routine maintenance. This section describes how to use the maintenance menu.

- ① Select [Maintenance Menu].
- ② Select a function to perform.

7.1 Maintenance

VIEW 3 Pro has a built-in diagnostic test function that allows the user to evaluate several critical variable parameters with only one simple step. Perform this function in case of splicer operation fault.

Operation Procedure



- ① Select [Maintenance] in [Maintenance Menu]
- ② Execute [Maintenance], then the following checks will be made.

No.	Check Item	Description
1	LED calibration	Measure and adjust the brightness of the LED.
2	Dust check	Check the optical path for dust or dirt and judges whether they disturb fiber observation. If contamination exists, press the return button twice to display the location.
3	Adjust Position	Automatic fiber adjustment
4	Motor Calibration	Automatically calibrate the speed of 6 motors.
5	Stabilize Electrodes	Accurately measure the position of the electrodes by ARC discharge.
6	Arc Calibration	Automatically calibrate the arc power factor and fiber splicing position.

7.2 Replace Electrodes

As electrodes are worn out during the splicing process, oxide generated on the tips of electrodes should be regularly eliminated. It is recommended that the electrodes should be replaced after 4500 arc discharges. When the number of arc discharges reaches a count of 4500, a message prompting to replace the electrodes is displayed immediately after turning on the power. Using the electrodes without a replacement will result in greater splice loss and reduced splice strength.

Replacement Procedure

- ① Select [Replace Electrodes] in [Maintenance Menu].
- ② Instruction messages will appear on the screen to turn off the power. Then turn off the splicer.
- ③ Remove the old electrodes.
 - I) Loosen screw located on electrode cover.
 - II) Take electrodes out of the electrode covers. (Electrodes are fixed in electrode cover)

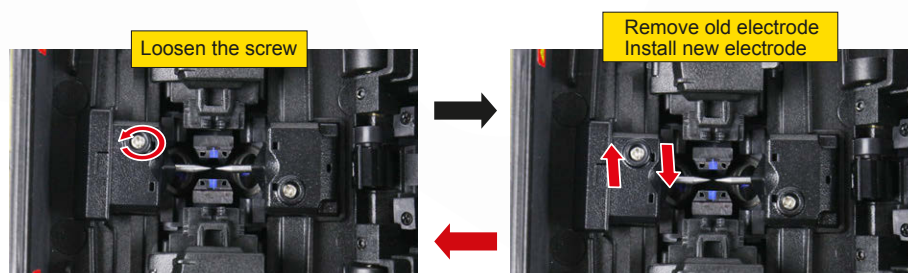

- ④ Clean the new electrodes with alcohol-impregnated clean gauze or lint-free tissue, and install them in the splicer.
 - I) Insert the electrodes in the electrode covers.
 - II) Place the electrode covers on the splicer, and tighten the screws.

⚠ Note:

Do not pull out wiring when replacing electrode. Do not exceed the normal finger strength when tightening screw.

- ⑤ INNO Instrument strongly recommends all users to do stabilizing electrodes and arc calibration after electrodes replacing to keep good splice results and splice strength (Details are described below).

7.3 Stabilize Electrodes

As electrodes are worn out during the splicing process, oxide generated on the tips of electrodes should be regularly eliminated. It is recommended that the electrodes should be replaced after 4500 arc discharges. When the number of arc discharges reaches a count of 4500, a message prompting to replace the electrodes is displayed immediately after turning on the power. Using the electrodes without a replacement will result in greater splice loss and reduced splice strength.

Operation Procedure

- ① Select [Stabilize electrodes].
- ② Place prepared fibers into the splicer for splicing.
- ③ Press [S] button, and the splicer will begin to stabilize the electrodes automatically in the following procedures:
 - ◆ Repeat arc discharge five times to measure the arc position.
 - ◆ Perform splicing rapidly.
 - ◆ Perform stabilizing electrodes 20 times consecutively to precisely locate the electrodes position.

7.4 Motor Calibration

Motors are adjusted at the factory before shipping. However, settings may be changed in various reasons. This function automatically calibrates the press motors.

Operation Procedure

- ① Select [Motor Calibration] in [Maintenance Menu].
- ② Load prepared fibers in the splicer and press [Set] button.
- ③ Press motors are automatically calibrated. Upon completion, message will be displayed.

⚠ Note:

* Perform this function when "Fat " or "Thin" error occurs, or fiber aligning or focusing takes too much time.

Operation Procedure

- ① After you have selected [Arc Calibration] in maintenance menu, an image of [Arc Calibration] will be displayed on the screen.
- ② Set prepared fibers on the splicer, press [Set] button to begin ARC Calibration.

⚠ Note:

* Use standard SM, DS or MM fiber for arc calibration. * Ensure clean fibers for arc calibration. Dust on the fiber surface affects arc calibration.

- ③ After Arc calibration, 2 numeric values will be displayed on the screen. When values on the right side are up to 11 ± 1 , the splicer will prompt out message for completion, otherwise the fiber needs to be cleaved again for Arc discharge calibration till message for completion prompted out.

7.5 Dust Check

Through image acquisition, the splicer detects dust and contaminants on the splicer, camera, and objective lenses that may result in improper splicing. This function checks the optical path for the presence or absence of contaminants, and judges whether they will affect the quality of fiber splicing.

Operation Procedure

- ① Select [Dust check] in [Maintenance menu].
- ② If fibers are set in the splicer, remove them and press [Set] again to start the dust check.
- ③ If dust is detected during the dust check process, the message “Failed” will be displayed on screen.
Then clean the objective lenses, and [Dust check] until the message "Complete" is shown on screen.

⚠ Note:

If contamination still exists after cleaning the objective lenses, please contact your nearest sales agent.

7.6 Electrode Setting

This function is used to set electrode. Electrodes are recommended to be replaced with new one every 4500 times' splicing operation to ensure splice quality.

- ① Enter into[Maintenance Menu] to select [Replace Electrodes]-[Electrode Setting].
- ② Set electrode caution and electrode warning.

Parameter	Description
Electrode caution	When discharge count of electrode more than set count, message “caution! Replace electrodes” will prompt out as you start fusion splicer. The count's parameter is recommended to be set as “4500”.
Electrode warning	When discharge count of electrode more than set count, message “warning! Replace electrodes” will prompt out as you start fusion splicer. The count's parameter is recommended to be set as “5500”.

7.7 Update Software

- ① Select [Update Software] in the [System Setting] interface.
- ② After you have clicked [OK], the splicer will automatically start the upgrade process, and the splicer will restart after the upgrade is complete.

Chapter 8 - Other Functions & Utilities

8.1 Data Storage

This splicer stores up to 10,000 splicing results. Contents of data stored are different depending on splicing mode.

Display Splice Record

Splicing results stored in the memory can be displayed with image. Enter [Splice Mode] -> [Data Storage] Menu and Select [Display Splice Record] to view.



Edit Splice Record

Available to enter Splice location information. It is saved with splice data.

Delete Splice Record

Splicing results can be cleared by part or whole.

- ① Enter [Delete/Export Splice Record], and select period to search for splice data.
- ② Select [Delete] or [Export] and [Confirm].
- ③ USB should be inserted before proceeding [Export] data.
- ④ Selected Splice Record will be made of Text file, image file, Pdf file, Excel file.



8.2 Menu Lock

If using "Menu Lock", each function may be locked by device owner preventing them from being changed.

- ① Enter [Splice Mode] - [Menu Lock] and device password.
- ② Switch functions which should be locked to "On"

8.3 Time Lock

8.3.1 Time Lock setting

- ① Enter [main menu] - [System Setting] - [System Setting] - [Time Lock]
- ② Enter device password
- ③ Available to set up to 6 dates [YY/MM/DD] for Time Lock
- ④ Press “R” button to reset the date
- ⑤ Press “o” button to save after setting
- ⑥ Check save notification on bottom of screen, “Data save done!”
- ⑦ Device is locked on set dates, enter device password to unlock

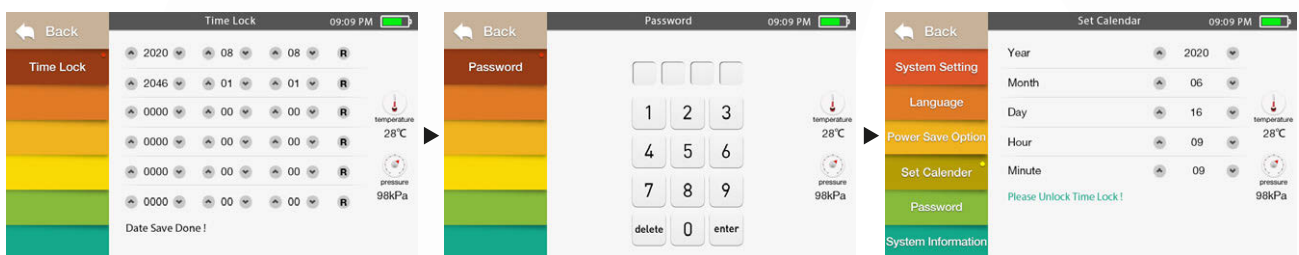

8.3.2 Remark

- ① Passed Time Lock date is deleted
- ② Not allow to enter “Set Calendar” while Time Lock is working
- ③ Time Lock uses device password

8.4 System Setting

Parameter	Description
Buzzer	Sets the sound volume of the buzzer.
Temperature Unit	Sets the unit of temperature.
Automatic Heating	If select [On], when the fiber is placed into heat oven, which will automatically execute heating.
Dust Check	Check if there is dusk in the imaging area. Set the dust check function, OFF by default, if select ON, duck check will be performed automatically when turn on the splicer.
Pull Test	Set the pull test, ON by default, if select OFF, pull test will not be performed. Press RESET manually for reset.
White LED	White LED switch.
Password Lock	Sets to enter system through password.
Reset	Restore factory setting.
Update Software	Splicer software update.
Language	Sets a language to be displayed on the screen.
Power Save Option	Sets the time of [Monitor Shut Down], time of [Splicer Shut Down] and LCD brightness.
Set Calendar	Sets the system time.
Change password	Changes the password to access some menus as [Power on Option] and [Menu Lock]. At the time of shipment from the factory, the password is set as [0000]. If you have forgotten your password after you changed another one, contact the sales agency.

Power Save Option

This function is important for power conservation. If the power saving function is not set during battery pack use, the number of splice cycles will decrease.

- (1) Insert a power unit and turn on the splicer.
- (2) Select [Power Save Option] in [System Setting] menu.
- (3) Change value of [Monitor Shut Down] and [Splicer Shut Down]

Parameter	Description
Monitor Shut Down	To avoid power loss when battery is used, setting this function turns off the power supply to the LCD monitor if the splicer does not operate after a certain period of time. When the power supply for monitor turns off, the LED near the power key []blinks. Press any key to turn on the LCD monitor.
Splicer Shut Down	Automatically turns off the power supply of the splicer if it performs no operation for a long period of time. The function serves to prevent the battery capacity from running low.

8.5 System Information

After selecting [System Information], the following messages will be shown on the screen:

Parameter	Description
Machine Serial NO.	Display the fusion splicer' s serial number.
Software Version	Display the fusion splicer' s software version.
FPGA Version	Display FPGA' s version.
Total Arc Count	Display total arc discharge count.
Current Arc Count	Display arc discharge count after electrode change. The parameters will be zero cleared or reset after replacing electrodes.
Last Maintenance	Display maintenance date at last time.
Production Date	Display the date of production of the machine.

Chapter 9 - VIEW PRO MANAGER

9.1 Preparation

- * Load battery and turn on the device.
- * Detach the SIM card Tray from under the USB cover of the splicer
- * Insert Nano SIM card to slot on the right side of machine.



***Only Nano-SIM Card Support**

9.2 Network Setting

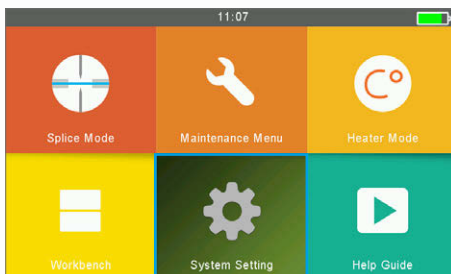

1) Go to “System Setting”

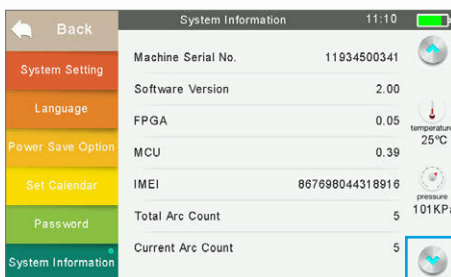

2) Go to second page of System Setting

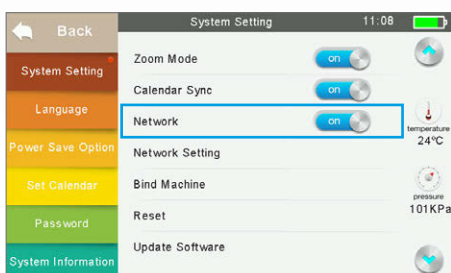

3) Check “Network” is ON

- * Networks status can be observed on workbench interface
- * Check Network and GPS activation icon on workbench (GPS signal is activated at open area)

ICON	Description
	GPS is activated
	GPS is not activated
	Network is activated
	Attempt to activate Network
	No SIM Card

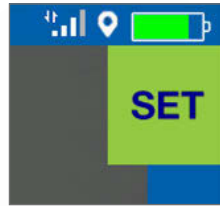

- * In case of Network fail, please refer to below.
 - SIM card should be unlocked. [Smartphone- setting- “Set up SIM card lock”]
 - Enter the APN information manually on “Network Setting”
 - If APN requires password, enter it to Network setting on the splicer. [Splicer- System menu-Network Setting]

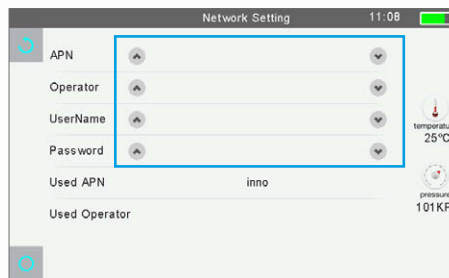
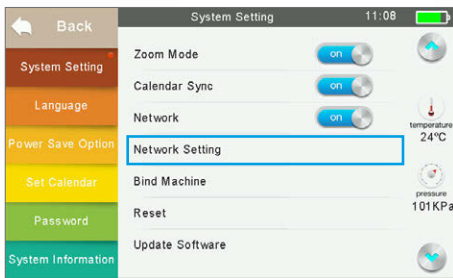

9.3 Access to the VIEW PRO MANAGER

- * Enter to View Pro Manager (<https://www.inno-viewpro.com>)



9.4 Create New Account

- * Create new account with your e-mail address

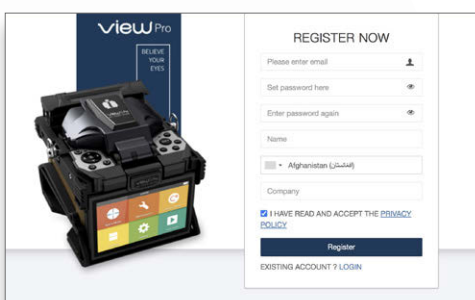

9.5 Register the Device

Name	Model	Authority	IMEI Number	ICID Number	Serial Number	Shock Block Life	Battery	State	Update Time	Online	Password Lock	Operation
VIEW3Pro_wq	View3 Pro	User	867698043367112	898601980771779642	12018001001	Default	30	Default Standby	2021-02-07 10:44:43	Online	🔒	🔄
View5 Pro zs	View5 Pro	User	867698043236457	898601980771779642	02000618013	Default	0	Default Standby	2021-02-03 16:30:18	Offline	🔒	🔄
VIEW5-PRO	View5 Pro	User	867698043361808	89860319746311338358	01108020211	Default	0	Default Standby	2021-01-09 09:33:43	Offline	🔒	🔄
VIEW3-12#	View3 Pro	User	867698043328303	89860319746311338358	12075283584	Default	30	Default Standby	2021-01-08 13:18:26	Offline	🔒	🔄
VIEW3-41	View3 Pro	User	867698043364158	89860786151730018269	01506005041	Default	-	Default Standby	2020-12-19 15:13:53	Offline	🔒	🔄
VIEW5PRO-5	View5 Pro	User	867698043362718	89860786151730018271	12001340011	Default	30	Default Standby	2020-12-04 14:40:19	Offline	🔒	🔄
VIEW12R-7	View12R Pro	User	867698043322314	89860786151730018269	05018001001	Default	30	Default Standby	2020-12-01 11:27:07	Offline	🔒	🔄
VIEW8PRO	View8 Pro	User	867698044900125	-	11004020001	Default	100	Default Standby	2020-11-19 19:58:47	Offline	🔒	🔄
VIEW8-2#	View8 Pro	User	867698043236820	8918720400043388598	10015002023	Default	80	Default Standby	2020-10-23 15:52:24	Offline	🔒	🔄
VIEW8-4#	View8 Pro	User	867698043236689	8982067590007672729F	10015004023	Default	90	Default Standby	2020-10-23 15:52:23	Offline	🔒	🔄

- 1) Go to “Device” menu
- 2) Click “Add” button
- 3) Enter the Serial Number
- 4) Enter the IMEI Number
- 5) Click 🔍 button
- 6) Select Device Group
- 7) Select Your Authority
- 8) Click “Change”
- 9) Click “Bind Splice”

- * Serial number & IMEI number can be found on system information
- * Manager Authority : Able to delete a User and Lock the splicer remotely
- * User Authority : Only available to access for device data

- 10) Go to “System Setting” of Splicer
- 11) Click “Bind Machine”

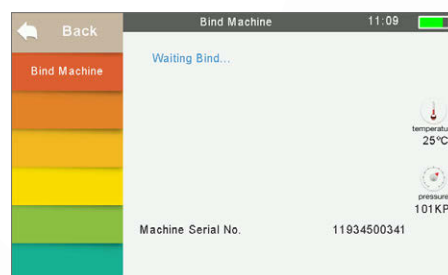
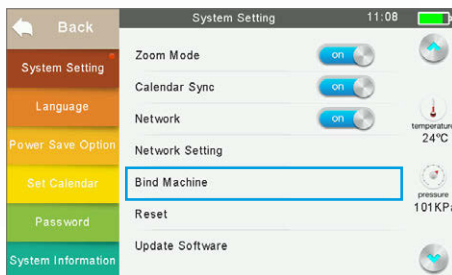

- 12) Tap “Accept”
- 13) Splicer is now registered on VIEW PRO MANAGER cloud

9.6 Feature of VIEW PRO MANAGER

9.6.1 Monitor

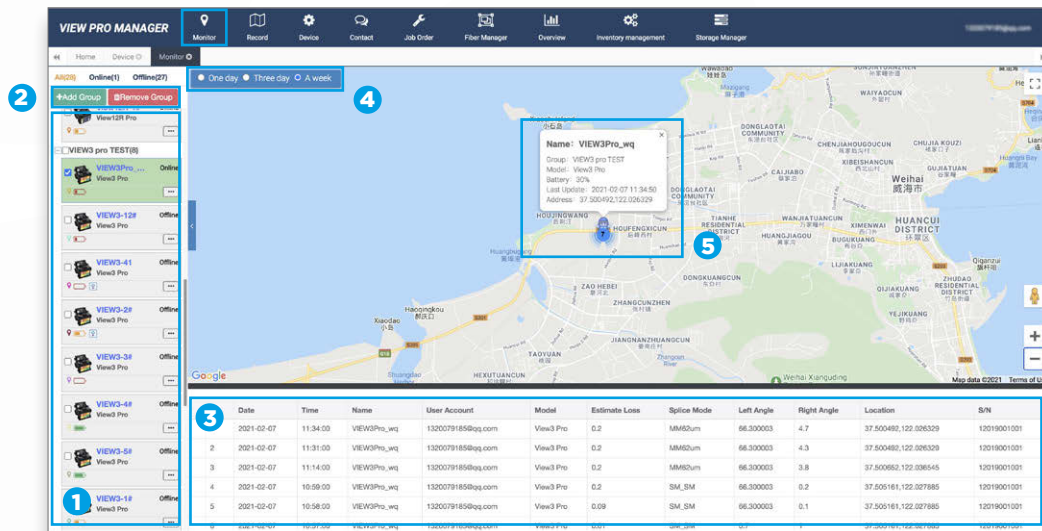

- 1) Device list with status icons (electrode warning, battery, SW version).
* Default grouping cannot be deleted.
- 2) Add/Remove group, group management.
- 3) Splice data of selected devices (User, Model, Estimated loss, Location, etc).
- 4) Select the period to search splice data
- 5) Current device location with device information (location, name, model, etc).

9.6.2 Record

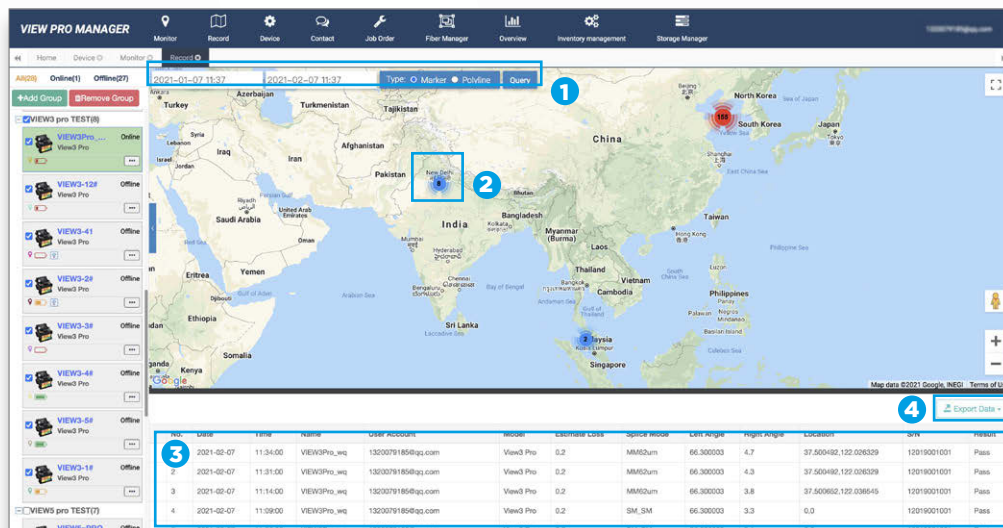





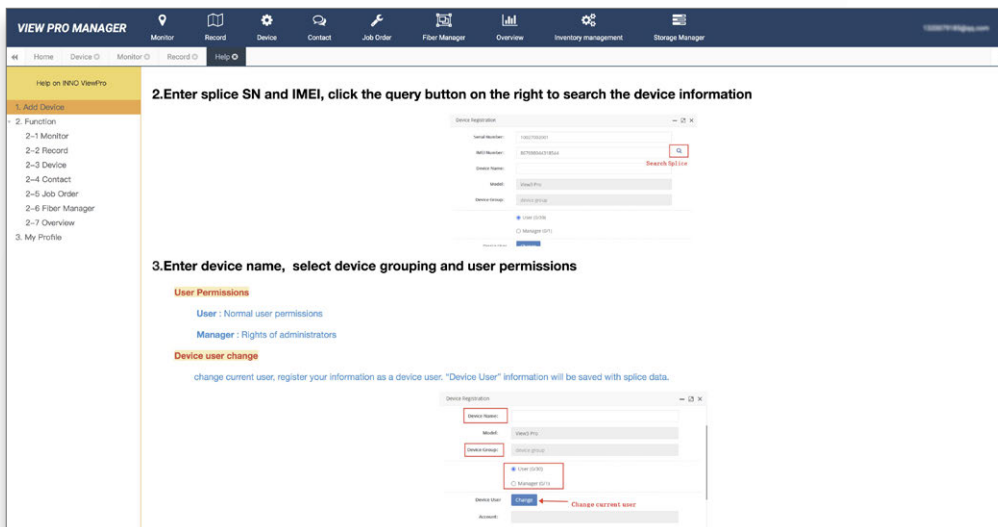
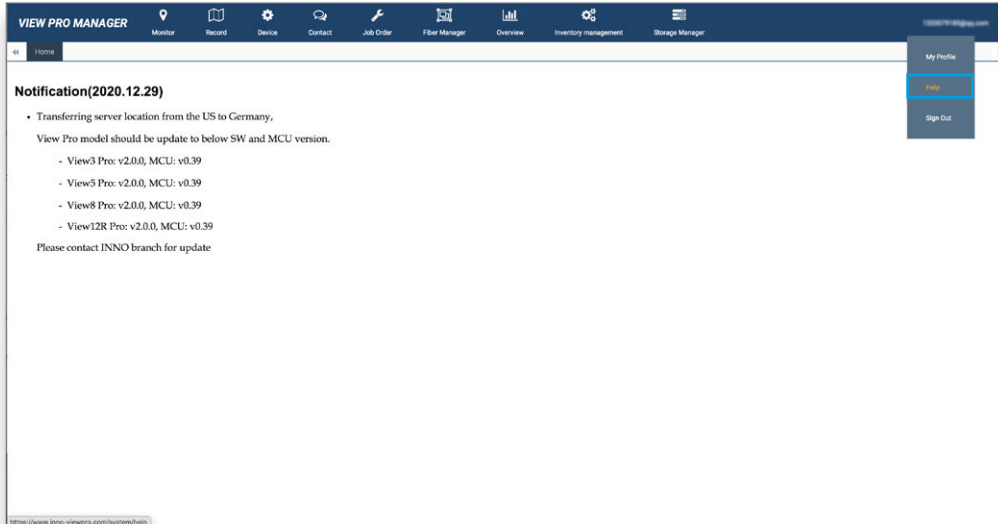

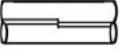

- 1) Period selection and data type for selected devices.
 - Marker: Splice point with count information on the map.
 - Ployline: Travel route of the device on the map.
- 2) Splice point with count information.
- 3) Splice data in detail for selected period.
- 4) Available to export filtered splice data into excel file.
 - Location of device which has no previous GPS record is saved to "0, 0"

- More Introduction and guidance can be found in “HELP” under account menu. (Under developing)

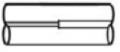

Appendix I

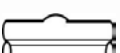
High Splice loss: Cause and remedy

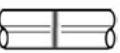
Symptom	Name	Cause	Remedy
	Fiber core axial offset	There' s dust in V-grooves and fiber hammer	Clean the V-grooves and fiber hammer
	Fiber core angle error	There' s dust in V-grooves and fiber hammer	Clean the V-grooves and fiber hammer
		Bad fiber end-face quality	Check the cleaver
	Fiber core bending	Bad fiber end-face quality	Check the cleaver
		Pre-fuse power too low or pre-fuse time too short.	Increase [Pre-fuse Power] and/or[Pre-fuse Time].
	The mode field diameters mismatch	Arc power not adequate	Increase [Pre-fuse Power] and/or[Pre-fuse Time].
	Dust combustion	Bad fiber end-face quality	Check the cleaver
		Dust still present after cleaning fiber or cleaning arc.	Clean fiber thoroughly or increase[Cleaning Arc Time]
	Bubbles	Bad fiber end-face quality	Check the cleaver
		Pre-fuse power too low or pre-fuse time too short.	Increase [Pre-fuse Power] and/or[Pre-fuse Time].
	Separation	Fiber stuffing too small	Perform [Arc Calibration].
		Pre-fuse power too high or pre-fuse time too long.	Decrease [Pre-fuse Power] and/or [Pre-fuse Time].
	Fat	Fiber stuffing too much	Decrease [Overlap] and Perform [Arc Calibration].
	Thin	Arc power not adequate	Perform [Arc Calibration].
		Some arc parameters not adequate	Adjust [Pre-fuse Power], [Pre-fuse Time] or [Overlap]
	Splicing line	Some arc parameters not adequate	Adjust [Pre-fuse Power], [Pre-fuse Time] or [Overlap]

⚠ Note:

When different optical fibers (different diameters) or multi-mode fibers splicing, they will produce a vertical line which we call the "splicing lines" in a subsequent point, this does not affect splicing quality (splicing loss and splicing strength).

Appendix II

Error Message List

An error message may appear on the screen when using a splicer, the solution precisely as shown in the list below. If it is not possible to eliminate the problem, maybe some faults occur in the fusion splicer. Consult your sales agency.

Error Message	Cause	Solution
Left Fiber Place Error	The fiber end-face is placed on the electrode centerline, or beyond it.	Press the “R” button, and set the fiber end-face between the electrode centerline and the V-groove edge.
Right Fiber Place Error		
Press Motor Distance Over Limit	The fiber is not set correctly at the bottom of the V-groove. The fiber is not located in the Camera’s field of view.	Press the “R” button; re-position the fiber again to seat it correctly at the bottom of the V-groove.
Press Motor Error	Motor might be damaged.	Consult your nearest sales agency.
Search Fiber End face Failed	The fiber is not set correctly at the bottom of the V-groove.	Press the “R” button; re-position the fiber again to seat it correctly at the bottom of the V-groove.
Arc Failure	Arc Discharge did not occur.	Assure the electrodes are in proper position; Replace the electrodes.
Align Motor Distance Over Limit	The fiber is not set correctly at the bottom of the V-groove.	Press the “R” button , re-position the fiber again to seat it correctly at the bottom of the V-groove.
Search Fiber Clad Failed	The fiber is not set correctly at the bottom of the V-groove.	Press the “R” button , re-position the fiber again to seat it correctly at the bottom of the V-groove.
Fiber Clad Gap Wrong	There’ s dust or dirt on the fiber surface	Prepare the fiber (stripping, cleaning, and cleaving) again.
Unknown Fiber Type	There’ s dust or dirt on the fiber surface	Prepare the fiber (stripping, cleaning, and cleaving) again.
	Mismatch Fibers	Use an appropriate splice mode other than AUTO splice mode to re-splice.
	Non-standard optical fibers	AUTO splice mode can only identify the standard fibers such as SM, MM, NZ.
Fiber Clad Over Limit	The fiber is not located in the Camera’s field of view.	Adjust the fiber position and do “motor calibration” for maintenance.
Focus Motor Home position Error	The fusion splicer is hit by force during splicing operation.	Carry out “motor calibration” for maintenance. If the problem still can’t be solved, contact with agency.
Fiber End face Gap Wrong	Too much [Overlap] setting	Adjust or initialize [Overlap] setting.
	The motor is not calibrated	Do [Motor Calibration] maintenance.
Motor Distance Over Limit	The fiber is not set correctly at the bottom of the V-groove.	Press the “R” button , re-position the fiber again to seat it correctly at the bottom of the V-groove.
	There’ s dust or dirt on the fiber surface	Prepare the fiber (stripping, Cleaning and cleaving) again.
	There’ s dust or dirt on the fiber surface	Execute the [Dust Check] after cleaning the lenses and mirrors.
Fiber Mismatch	The fibers on the two sides are not the same	It may result in large splice loss if you continue to splice, Please use the proper splice mode corresponding to the fibers.
Cleave Angle Over Limit	Bad fiber end-face	Prepare the fiber (stripping, cleaning, and cleaving) again., Check the condition of the fiber cleaver. If the blade is worn, rotate the blade to a new position.
	[Cleave Limit] is set too low.	Increase the “Cleave Limit” to an adequate limit. (standard value: 3.0°)
Core Angle Over Limit	[Offset Limit] is set too low.	Increase the “Core Angle Limit” to an adequate limit. (standard value: 1.0°).
	Dust or dirt is on the V-groove or the clamp chip.	Clean the V-groove or the clamp chip, prepare and reposition the fiber again.

Fiber Axis Align Failed	Axial offset (>0.4um)	Prepare the fiber (stripping, cleaning, and cleaving) again.
	The motor is not calibrated	Do the "Motor Calibration" maintenance.
Fiber is Dirty	There's dust or dirt on the fiber surface	Prepare the fiber (stripping, cleaning, and cleaving) again.
	Dust or dirt is on the lens or LEDs	Execute the "Dust Check". If dust or dirt exists, clean the lenses or LEDs
	"Cleaning Arc time" is too short	Set the "Cleaning Arc time" to 180ms
	Splice the fibers whose cores are difficult to find by the way of core alignment.	Splice the fibers whose cores are difficult to find by MM splice mode (cladding layer alignment).
Fat Splicing Point	Too much [Overlap] setting	Adjust or initialize "Overlap" setting.
	The motor is not calibrated.	Calibrate the arc power with the "Arc Calibration" function.
Thin Splicing Point	Inadequate arc power	Calibrate the arc power with the "Arc Calibration" function.
	Pre-fuse power or time is set too high	Adjust or initialize "Pre-fuse Power" or "Pre-fuse Time" settings.
	Insufficient "Overlap" setting	Adjust or initialize "Overlap" setting

Appendix III

The following gives the solution of some of the common problems for reference. If you cannot solve the problems, please contact the manufacturer directly.

1. Power does not turn off when press “ON/OFF” button.
 - ★ Press and hold the key “ON/OFF” until the LED flashes, release the button, and the splicer will be turned off.
2. Few splices can be made with a fully charged battery pack.
 - ★ Enable it to conserve power usage.
 - ★ The battery power degrades due to memory effects and Long-term storage. Recharge the battery after a fully discharging.
 - ★ The battery pack has reached the end of its service life. Install a new battery pack.
 - ★ Don't use the battery at a low temperature.
3. Error message appears on monitor.
 - ★ Refer to appendix II .
4. High splice loss
 - ★ Clean the V-grooves, fiber clamps, wind protector LEDs, and objective lenses.
 - ★ Replace the electrodes.
 - ★ Refer to appendix I .
 - ★ The splice loss varies according to the cleave angle, arc conditions and fiber cleanliness.
5. Monitor suddenly turned off.
 - ★ when you enable the power saving function, the splicer will switch to the power saving state after an extended period of splicer inactivity. Press any key to return to the normal state.
6. Splicer power suddenly turned off.
 - ★ when you enable the power saving function, the splicer will turn the splicer power off after an extended period of inactivity.
7. Mismatch between Estimated splice loss and Actual splice loss.
 - ★ The estimated loss is a calculated loss, so it can be used for reference only.
 - ★ The optical components of the splicer may need to be cleaned.
8. Fiber protection sleeve does not shrink completely.
 - ★ Extend the heating time.
9. Method to cancel heating process.
 - ★ Press the “HEAT” button to cancel the heating process. And the LED will be turned off.
10. Fiber protection sleeve adhered to heating plate after shrinking.
 - ★ Use a cotton swab or a similar soft tip object to push and remove the sleeve.
11. Forgot passwords.
 - ★ Contact your nearest sales agency.
12. No arc power change after [Arc Calibration].
 - ★ An internal factor is calibrated and adjusted for the specific arc power selected. The displayed arc power in each splice mode does not change.
13. Forget to put the optical fiber during the process of maintenance function.
 - ★ It is invalid to press the return key. You need to open the wind cover and put the prepared fibers and press the “SET” or “R” button to continue.
14. Fail to upgrade
 - ★ When users use the "new" U-disk to upgrade, the splicer may not be able to correctly identify the upgrade program file; you need to reset the U-disk, and restart the splicer.
 - ★ Check whether the upgrade file name and the format are correct.
 - ★ If you cannot solve the problems, please contact the manufacturer directly.
15. Others
 - ★ Please refer to the training video in detail.

The End

* Products models and specifications are subject to change without prior notice.

